

120-56

■ **PRODUCT FEATURES**

- Style: Transitional
- Collection: Transition
- Temperature Controlled By Handles
- Cross Handles
- 
- 

■ **TECHNICAL DETAILS**

ADA Compliance: No  
 Drain Assembly Material: Brass  
 Fitting Hole Diameter: 1 1/8"  
 Number of Holes: Three Hole  
 Number of Handles: Two  
 Handle Turn Angle: Quarter Turn  
 Spout Reach: 7 1/2"  
 Installation Type: Wall Mounted  
 Primary Material: Brass  
 Valve Material: Ceramic  
 Flow Restriction: 1.2 gpm  
 Water Pressure Maximum: 85 PSI  
 Water Pressure Minimum: 20 PSI  
 Water Pressure Recommended: 60 PSI

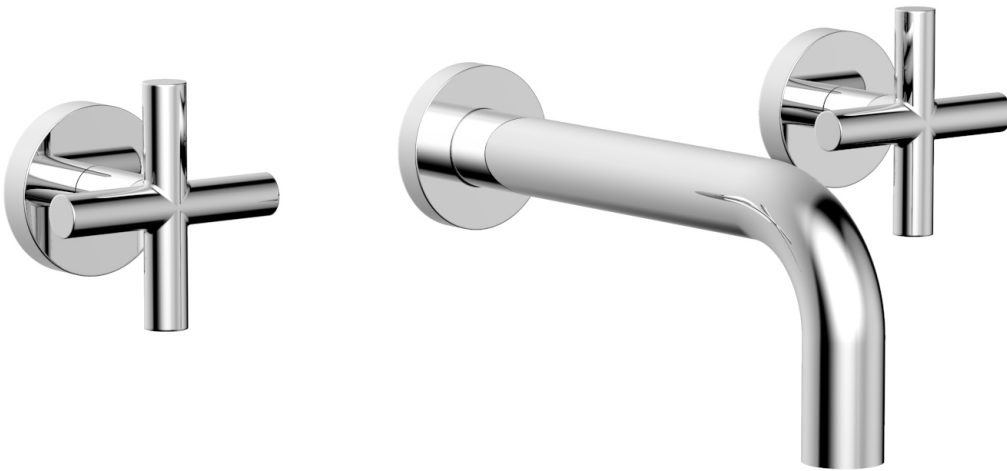

■ **PRODUCT DIMENSIONS**

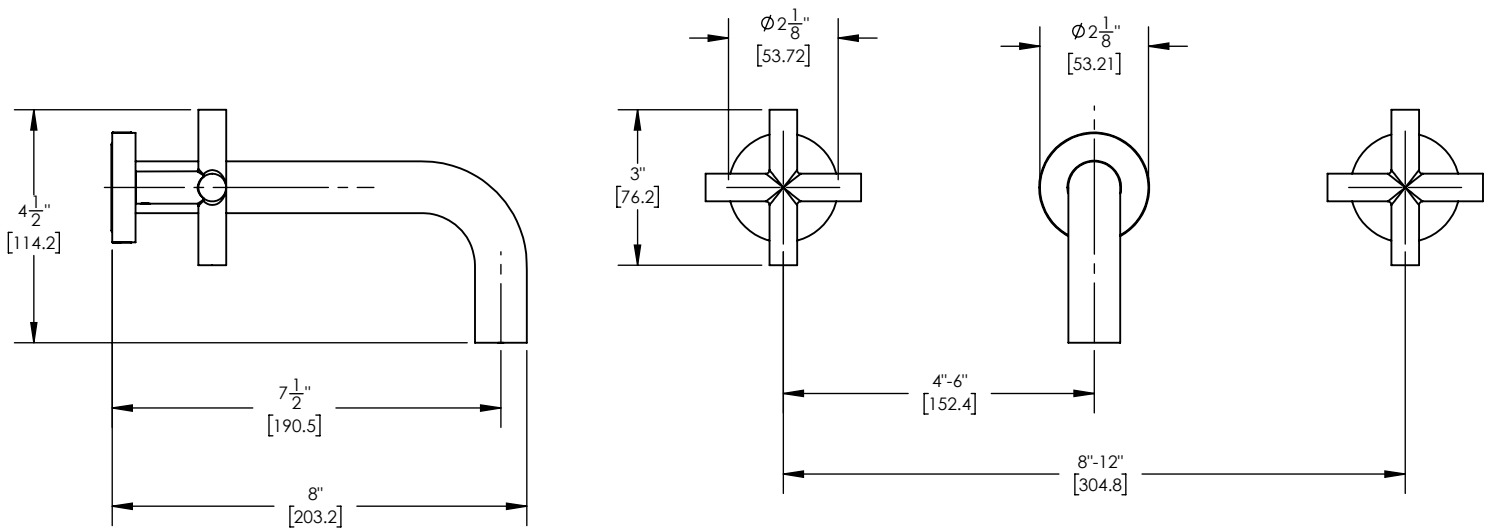

[www.phylrich.com](http://www.phylrich.com)

1261 Logan Avenue, Costa Mesa, California 92626.  
 Phone: 714.361.4800 Fax: 714.617.3120

Rev-



**CODES & STANDARDS**

ASME A112.181/ CSA B1251, ASME 112.18.2/ CSA B125.2, ANSI NSF, CEC

**WARRANTY**

Mechanical Warranty: 10 Years from date of purchase.  
 Finish Warranty: See catalog for further information.